

DETAILED PARTS AND ASSEMBLY PROCEDURE

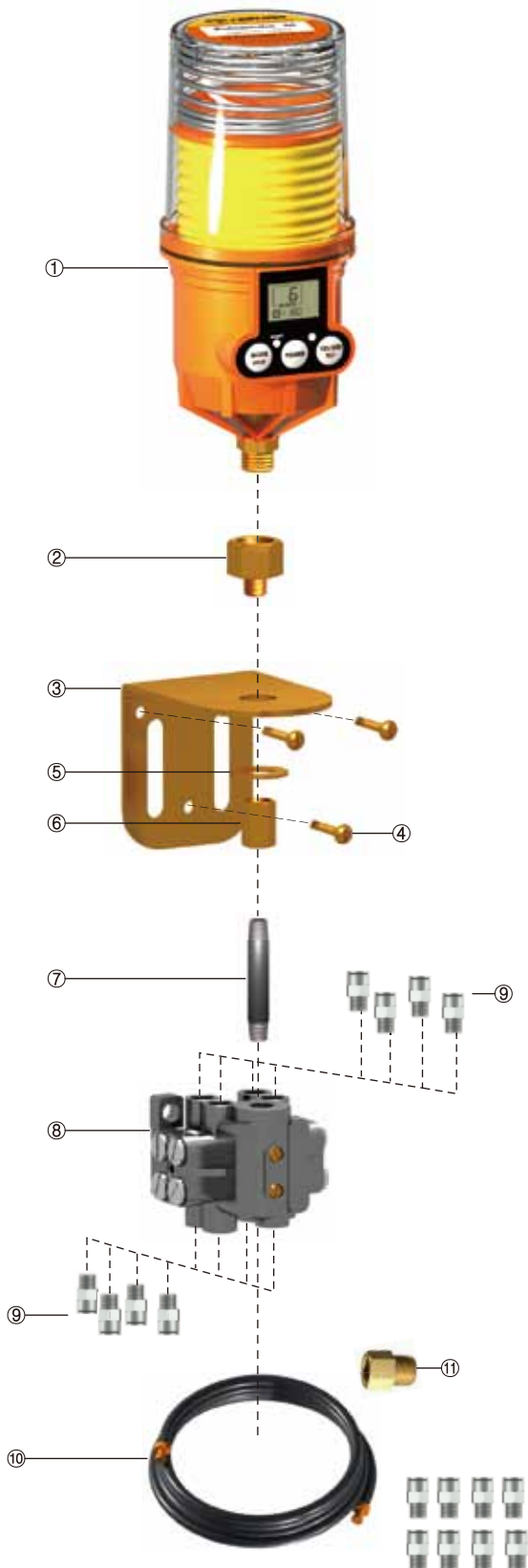

LIST	PART No.	DESCRIPTION	Q'TY
①	M250	Pulsarlube M	N/A
②	A002	PT 3/8"F x PT 1/8"M Adapter	1
③	B002	Mounting Bracket	1
④	B051	Self Drilling Screws	3
⑤	B057	Steel Washer	1
⑥	A012	PT 1/8"F x PT 1/8"F Adapter	1
⑦	A106	PT 1/8"M Pipe Connector x 50mm	1
⑧	B012	Grease Type Divider Block U-6R	1
⑨	A240	PC6 - PT 1/8"M Fitting Connector	16
⑩	A214-1	1/4"(6mm) O.D Nylon Tubing (10ft)	4
⑪	A243	Metric to inch thread converter for bearing zerk (USA only)	8

ASSEMBLY PROCEDURE

1. Install the mounting bracket (③) at a proper location using screws (④). It is good practice to mount the lubricator in close proximity to the bearing to keep feed lines as short as possible.
2. Insert the push-in fitting connectors (⑨) into the divider block. Only the open and threaded ports on the divider block are designed to dispense grease.
3. Screw the pipe connector (⑦) into the divider block (⑧) inlet and tighten.
4. Install the lubricator (①) using the provided adapter (②), washer (⑤), and socket (⑥) on the mounting bracket. Be sure to position the lubricator so that it will allow for easy adjustments.
5. Tighten and position the lubricator and divider block assembly facing forward.
6. Measure and cut the tube (⑩) to the desired length. Be sure the tube ends are cut clean and perpendicular and that no damage is present on the
7. Insert the tube into the push-in fitting connector (⑨) for a quick and easy leak-proof connection.
8. Program the monthly setting using the MODE button and use the provided dust cover for added protection.

COMMENTS

1. All Parts should be assembled tightly with PTFE tape.
2. For optimal performance with remote installation kits, using an NLGI #1 grade grease is recommended.
3. If the bearing lube point is NPT, use the thread converter (⑪).

Note : All parts above are Metric thread.